

DIAGRAMMA DELLE PORTATE (t)
 CAPACITY DIAGRAM (t)
 TRAGLASTDIAGRAMM (t)
 LASTENDIAGRAMM (t)
 TABLEAU DES CHARGES (t)
 DIAGRAMA DE LAS CARGAS (t)

JMG

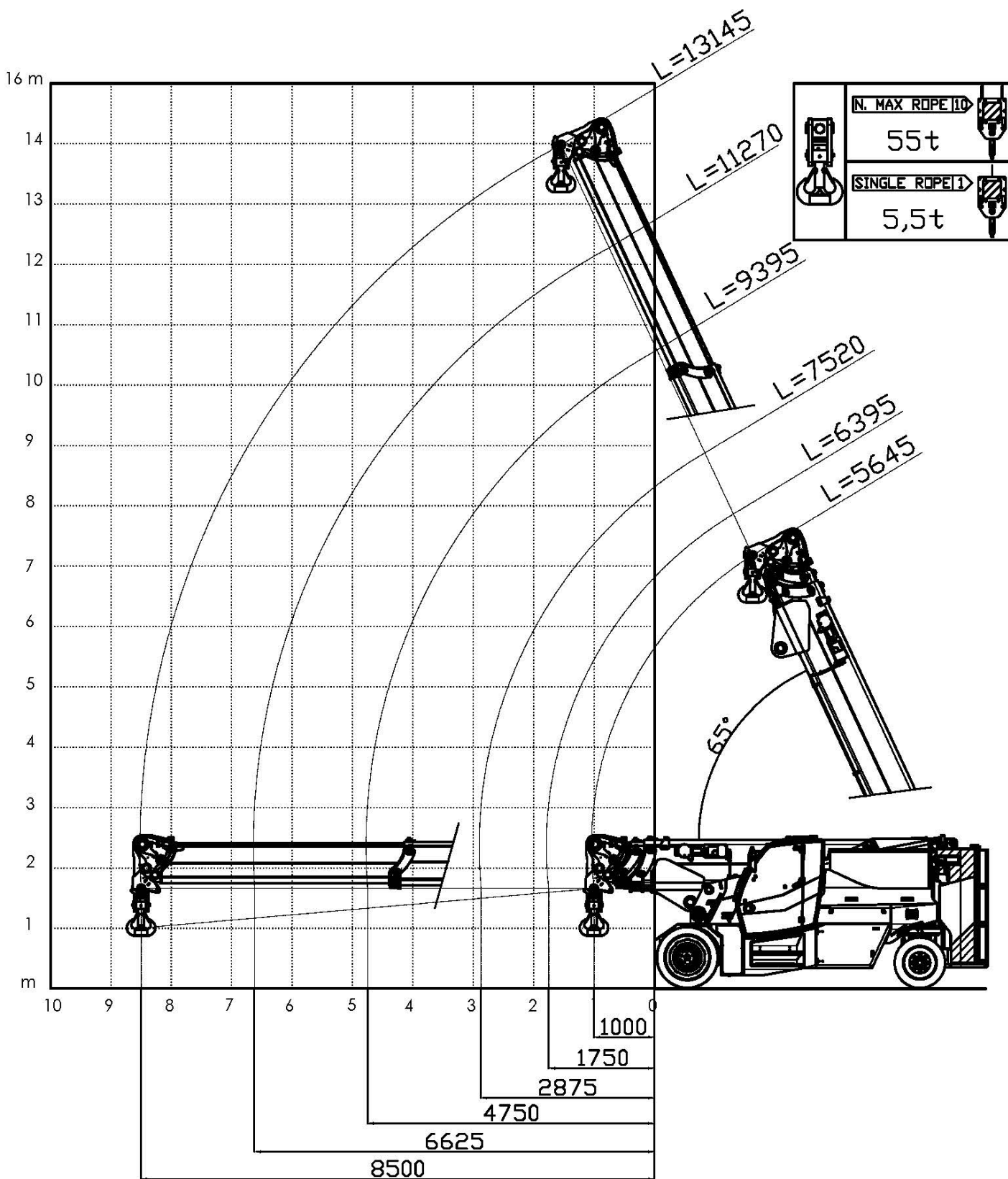



MC650/MC650S

Cod.: 090-TAR-08692 Scala 1:90

Diagramma di portata (t) - Capacity diagram (t)
 Traglastdiagramm (t) - Tableau des charges (t)
 Lastendiagramm (t) - Diagrama de las cargas (t)

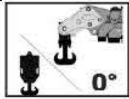
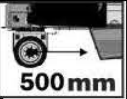





					Z1 Z3	Z2 Z4
						
	(t)	5645	6395	7520	9395	11270
	0	65	65	61,9	51,7	
	0,5	65	65	56,4	46,6	39,2
	1	65	64,7	51,8	42,3	37,3
	1,5		56	47,9	38,8	34
	1,75		49,3	46,2	37,2	32,4
	2			44,6	35,7	30,9
	2,5			36,8	33,1	28,2
	2,88			32,2	31,2	26,4
	3				30,6	25,9
	3,5				27,1	23,9
	4				23,7	22,2
	4,5				21	20,7
	4,75				19,8	20
	5					18,9
	5,5					17,1
	6					15,5
	6,5					14,2
	6,63					13,8
	7					13,1
	7,5					12,1
	8					11,2
	8,5					10

MC650/MC650S

090-DIA-08702

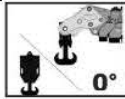
Diagramma di portata (t) - Capacity diagram (t)
 Traglastdiagramm (t) - Tableau des charges (t)
 Lastendiagramm (t) - Diagrama de las cargas (t)





					Z1 Z3	Z2 Z4	
							
	(t)	5645	6395	7520	9395	11270	13145
	0	65	65	61,9	51,7		
	0,5	65	65	56,4	46,6	39,2	
	1	65	64,7	51,8	42,3	37,3	
	1,5		51,1	47,9	38,8	34	30,5
	1,75		44,9	45,3	37,2	32,4	29,1
	2			40,6	35,7	30,9	27,7
	2,5			33,4	33,1	28,2	25,1
	2,88			29,3	29,7	26,4	23,4
	3				28,5	25,9	22,9
	3,5				24,6	23,9	21,1
	4				21,5	21,6	19,5
	4,5				19	19,1	18,1
	4,75				17,8	18,1	17,4
	5					17,1	16,9
	5,5					15,4	15,5
	6					14	14
	6,5					12,7	12,8
	6,63					12,4	12,5
	7						11,7
	7,5						10,8
	8						10
	8,5						9,2

MC650/MC650S

090-DIA-08703

Diagramma di portata (t) - Capacity diagram (t)
 Traglastdiagramm (t) - Tableau des charges (t)
 Lastendiagramm (t) - Diagrama de las cargas (t)

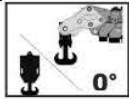
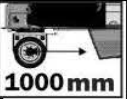



								Z1	Z2
								Z3	
									
(t)	5645	6395	7520	9395	11270	13145			
0	65	65	61,9	51,7					
0,5	65	65	56,4	46,6	39,2				
1	65	64,7	51,8	42,3	37,3				
1,5		54,9	47,9	38,8	34	30,5			
1,75		48,4	46,2	37,2	32,4	29,1			
2			43,7	35,7	30,9	27,7			
2,5			36	33,1	28,2	25,1			
2,88			31,6	31,2	26,4	23,4			
3				30,6	25,9	22,9			
3,5				26,5	23,9	21,1			
4				23,2	22,2	19,5			
4,5				20,6	20,7	18,1			
4,75				19,3	19,6	17,4			
5					18,5	16,9			
5,5					16,7	15,8			
6					15,2	14,8			
6,5					13,8	13,9			
6,63					13,5	13,6			
7						12,8			
7,5						11,8			
8						10,9			
8,5						10			

MC650/MC650S

090-DIA-08704

Diagramma di portata (t) - Capacity diagram (t)
 Traglastdiagramm (t) - Tableau des charges (t)
 Lastendiagramm (t) - Diagrama de las cargas (t)

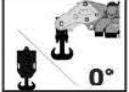
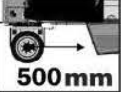
JMG[®]

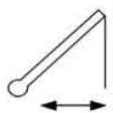



		 0°		 500mm		 0mm		Z1	Z2
								Z3	
	(t)	5645	6395	7520	9395	11270	13145		
	0	65	65	61,9	51,7				
	0,5	65	65	56,4	46,6	39,2			
	1	65	64,7	51,8	42,3	37,3			
	1,5		50,5	47,9	38,8	34	30,5		
	1,75		44,4	44,8	37,2	32,4	29,1		
	2			40,1	35,7	30,9	27,7		
	2,5			33	33,1	28,2	25,1		
	2,88			28,9	29,3	26,4	23,4		
	3				28,2	25,9	22,9		
	3,5				24,3	23,9	21,1		
	4				21,2	21,3	19,5		
	4,5				18,8	18,9	18,1		
	4,75				17,6	17,8	17,4		
	5					16,9	16,9		
	5,5					15,2	15,3		
	6					13,8	13,8		
	6,5					12,5	12,6		
	6,63					12,2	12,4		
	7						11,6		
	7,5						10,7		
	8						9,8		
	8,5						9		

MC650/MC650S

090-DIA-08705

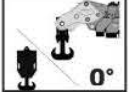
Diagramma di portata (t) - Capacity diagram (t)
 Traglastdiagramm (t) - Tableau des charges (t)
 Lastendiagramm (t) - Diagrama de las cargas (t)





					Z1	Z2	Z3
							
	(t)	5645	6395	7520	9395	11270	13145
	0	65	65	61,9	51,7		
	0,5	65	65	56,4	46,6	39,2	
	1	61,3	61,9	51,8	42,3	37,3	
	1,5		46	46,2	38,8	34	30,5
	1,75		40,4	40,8	37,2	32,4	29,1
	2			36,5	35,7	30,9	27,7
	2,5			30	30,3	28,2	25,1
	2,88			26,2	26,6	26,4	23,4
	3				25,6	25,6	22,9
	3,5				22	22,1	21,1
	4				19,2	19,3	19,3
	4,5				17	17,1	17,1
	4,75				15,9	16,1	16,1
	5					15,2	15,3
	5,5					13,7	13,7
	6					12,4	12,5
	6,5					11,2	11,3
	6,63					10,9	11,1
	7						10,4
	7,5						9,5
	8						8,8
	8,5						8

MC650/MC650S

090-DIA-08706

Diagramma di portata (t) - Capacity diagram (t)
 Traglastdiagramm (t) - Tableau des charges (t)
 Lastendiagramm (t) - Diagrama de las cargas (t)

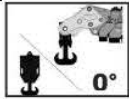
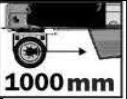



					Z1	Z2	
							
	(t)	5645	6395	7520	9395	11270	13145
	0	65	65	61,9	51,7		
	0,5	65	65	56,4	46,6	39,2	
	1	61	61,6	51,8	42,3	37,3	
	1,5		45,8	46	38,8	34	30,5
	1,75		40,2	40,6	37,2	32,4	29,1
	2			36,4	35,7	30,9	27,7
	2,5			29,9	30,2	28,2	25,1
	2,88			26,1	26,5	26,4	23,4
	3				25,5	25,5	22,9
	3,5				21,9	22	21,1
	4				19,1	19,2	19,2
	4,5				16,9	17	17
	4,75				15,8	16	16,1
	5					15,2	15,2
	5,5					13,6	13,7
	6					12,3	12,4
	6,5					11,2	11,3
	6,63					10,9	11
	7						10,3
	7,5						9,5
	8						8,7
	8,5						8

MC650/MC650S

090-DIA-08707

Diagramma di portata (t) - Capacity diagram (t)
 Traglastdiagramm (t) - Tableau des charges (t)
 Lastendiagramm (t) - Diagrama de las cargas (t)

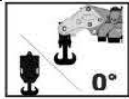
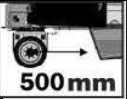



					Z1	Z2
						
	(t)	5645	6395	7520	9395	11270
	0	65	65	61,9	51,7	
	0,5	65	65	56,4	46,6	39,2
	1	56,2	56,8	51,8	42,3	37,3
	1,5		42,1	42,3	38,8	34
	1,75		36,9	37,4	37,2	32,4
	2			33,4	33,8	30,9
	2,5			27,4	27,7	27,8
	2,88			23,9	24,3	24,4
	3				23,3	23,4
	3,5				20,1	20,1
	4				17,5	17,6
	4,5				15,4	15,5
	4,75				14,4	14,6
	5					13,8
	5,5					12,4
	6					11,2
	6,5					10,1
	6,63					9,8
	7					9,3
	7,5					8,5
	8					7,8
	8,5					7,2

MC650/MC650S

090-DIA-08708

Diagramma di portata (t) - Capacity diagram (t)
 Traglastdiagramm (t) - Tableau des charges (t)
 Lastendiagramm (t) - Diagrama de las cargas (t)

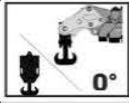
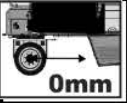



					Z1	Z2
						
	(t)	5645	6395	7520	9395	11270
	0	65	65	61,9	51,7	
	0,5	65	65	56,4	46,6	39,2
	1	51,3	51,9	51,8	42,3	37,3
	1,5		38,5	38,6	38,8	34
	1,75		33,7	34,1	34,6	32,4
	2			30,5	30,8	30,9
	2,5			25	25,3	25,3
	2,88			21,7	22,1	22,2
	3				21,2	21,3
	3,5				18,2	18,3
	4				15,8	15,9
	4,5				13,9	14
	4,75				13	13,2
	5					12,5
	5,5					11,1
	6					10
	6,5					9,1
	6,63					8,8
	7					8,3
	7,5					7,6
	8					7
	8,5					6,3

MC650/MC650S

090-DIA-08709

Diagramma di portata (t) - Capacity diagram (t)
 Traglastdiagramm (t) - Tableau des charges (t)
 Lastendiagramm (t) - Diagrama de las cargas (t)

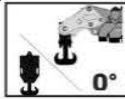
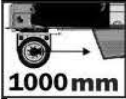
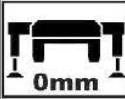
JMG®



		 0°	 1000mm	 0mm	Z1		
							
	(t)	5645	6395	7520	9395	11270	13145
	0	65	65	61,9	51,7		
	0,5	65	65	56,4	46,6	39,2	
	1	48,9	49,5	49,7	42,3	37,3	
	1,5		36,7	36,8	37,3	34	30,5
	1,75		32,1	32,5	32,9	32,4	29,1
	2			29	29,4	29,4	27,7
	2,5			23,7	24	24,1	24,1
	2,88			20,6	21	21,1	21,1
	3				20,2	20,2	20,3
	3,5				17,3	17,3	17,4
	4				15	15,1	15,1
	4,5				13,2	13,3	13,3
	4,75				12,3	12,5	12,5
	5					11,8	11,8
	5,5					10,5	10,6
	6					9,5	9,5
	6,5					8,5	8,6
	6,63					8,3	8,4
	7						7,8
	7,5						7,1
	8						6,5
	8,5						5,9

MC650/MC650S

090-DIA-08710

Diagramma di portata (t) - Capacity diagram (t)
 Traglastdiagramm (t) - Tableau des charges (t)
 Lastendiagramm (t) - Diagrama de las cargas (t)

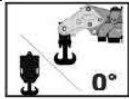
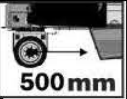
JMG[®]





		 0°	 500mm	 0mm	Z1			
								
	(t)	5645	6395	7520	9395	11270	13145	
	0	65	65	61,9	51,7			
	0,5	65	65	56,4	46,6	39,2		
	1	45,1	45,7	45,9	42,3	37,3		
	1,5		33,8	34	34,5	34	30,5	
	1,75		29,5	29,9	30,4	30,4	29,1	
	2			26,7	27,1	27,1	27,1	
	2,5			21,8	22,1	22,2	22,2	
	2,88			18,9	19,3	19,4	19,4	
	3				18,5	18,6	18,6	
	3,5				15,8	15,9	15,9	
	4				13,7	13,8	13,8	
	4,5				12	12,1	12,1	
	4,75				11,2	11,4	11,4	
	5					10,7	10,8	
	5,5					9,6	9,6	
	6					8,6	8,6	
	6,5					7,7	7,8	
	6,63					7,4	7,6	
	7						7,1	
	7,5						6,4	
	8						5,8	
	8,5						5,3	

MC650/MC650S

090-DIA-08711

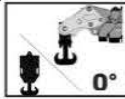
Diagramma di portata (t) - Capacity diagram (t)
 Traglastdiagramm (t) - Tableau des charges (t)
 Lastendiagramm (t) - Diagrama de las cargas (t)

JMG®



		 0°	 0mm	 0mm	Z1			
								
	(t)	5645	6395	7520	9395	11270	13145	
	0	65	65	61,9	51,7			
	0,5	63,2	63,4	56,4	46,6	39,2		
	1	41,3	41,9	42,1	42,3	37,3		
	1,5		30,9	31,1	31,6	31,6	30,5	
	1,75		27	27,4	27,8	27,9	27,9	
	2			24,4	24,8	24,8	24,8	
	2,5			19,9	20,2	20,2	20,2	
	2,88			17,2	17,6	17,7	17,7	
	3				16,9	16,9	16,9	
	3,5				14,4	14,4	14,5	
	4				12,4	12,5	12,5	
	4,5				10,8	10,9	11	
	4,75				10,1	10,3	10,3	
	5					9,7	9,7	
	5,5					8,6	8,6	
	6					7,7	7,7	
	6,5					6,9	7	
	6,63					6,6	6,8	
	7						6,3	
	7,5						5,7	
	8						5,1	
	8,5						4,6	

MC650/MC650S

090-DIA-08712

Diagramma di portata (t) - Capacity diagram (t)
 Traglastdiagramm (t) - Tableau des charges (t)
 Lastendiagramm (t) - Diagrama de las cargas (t)

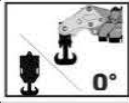
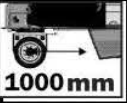



					NZ			
								
	(t)	5645	6395	7520	9395	11270	13145	
	0	65	65	61,9	51,7			
	0,5	46,1	46,3	46,4	46,6	37,9		
	1	29,8	30,4	30,5	31,3	31,3		
	1,5		22,2	22,3	22,9	22,9	22,3	
	1,75		19,2	19,6	20	20,1	20,1	
	2			17,4	17,8	17,8	17,8	
	2,5			14	14,3	14,4	14,4	
	2,88			12	12,4	12,4	12,5	
	3				11,8	11,9	11,9	
	3,5				10	10	10	
	4				8,5	8,6	8,6	
	4,5				7,3	7,4	7,4	
	4,75				6,7	6,9	6,9	
	5					6,4	6,5	
	5,5					5,6	5,7	
	6					4,9	5	
	6,5					4,3	4,4	
	6,63					4,1	4,3	
	7						3,9	
	7,5						3,5	
	8						3,1	
	8,5						2,6	

MC650/MC650S

090-DIA-08713

Diagramma di portata (t) - Capacity diagram (t)
 Traglastdiagramm (t) - Tableau des charges (t)
 Lastendiagramm (t) - Diagrama de las cargas (t)

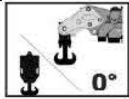
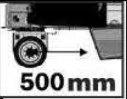



					NZ			
								
	(t)	5645	6395	7520	9395	11270	13145	
	0	65	65	61,9	51,7			
	0,5	43,1	43,3	43,4	44,7	35,4		
	1	27,7	28,3	28,4	29,2	29,2		
	1,5		20,6	20,8	21,3	21,3	20,8	
	1,75		17,8	18,2	18,6	18,7	18,7	
	2			16,1	16,5	16,5	16,5	
	2,5			13	13,3	13,3	13,3	
	2,88			11,1	11,5	11,5	11,5	
	3				10,9	11	11	
	3,5				9,2	9,2	9,3	
	4				7,8	7,9	7,9	
	4,5				6,7	6,8	6,8	
	4,75				6,1	6,3	6,3	
	5					5,9	5,9	
	5,5					5,1	5,2	
	6					4,5	4,5	
	6,5					3,9	4	
	6,63					3,7	3,8	
	7						3,5	
	7,5						3,1	
	8						2,7	
	8,5						2,3	

MC650/MC650S

090-DIA-08714

Diagramma di portata (t) - Capacity diagram (t)
 Traglastdiagramm (t) - Tableau des charges (t)
 Lastendiagramm (t) - Diagrama de las cargas (t)

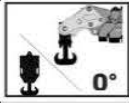
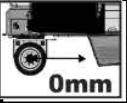

					NZ			
								
	(t)	5645	6395	7520	9395	11270	13145	
	0	65	65	61,9	51,7			
	0,5	40	40,2	40,3	41,6	33		
	1	25,6	26,2	26,4	27,2	27,2		
	1,5		19,1	19,2	19,7	19,8	19,3	
	1,75		16,4	16,8	17,3	17,3	17,3	
	2			14,9	15,2	15,3	15,3	
	2,5			11,9	12,2	12,3	12,3	
	2,88			10,1	10,5	10,6	10,6	
	3				10	10,1	10,1	
	3,5				8,4	8,4	8,5	
	4				7,1	7,2	7,2	
	4,5				6	6,1	6,2	
	4,75				5,5	5,7	5,7	
	5					5,3	5,3	
	5,5					4,6	4,6	
	6					4	4	
	6,5					3,4	3,5	
	6,63					3,2	3,4	
	7						3,1	
	7,5						2,7	
	8						2,3	
	8,5						1,9	

MC650/MC650S

090-DIA-08715