

DIAGRAMMA DELLE PORTATE (t)
 CAPACITY DIAGRAM (t)
 TRAGLASTDIAGRAMM (t)
 LASTENDIAGRAM (t)
 TABLEAU DES CHARGES (t)
 DIAGRAMA DE LAS CARGAS (t)

JMG

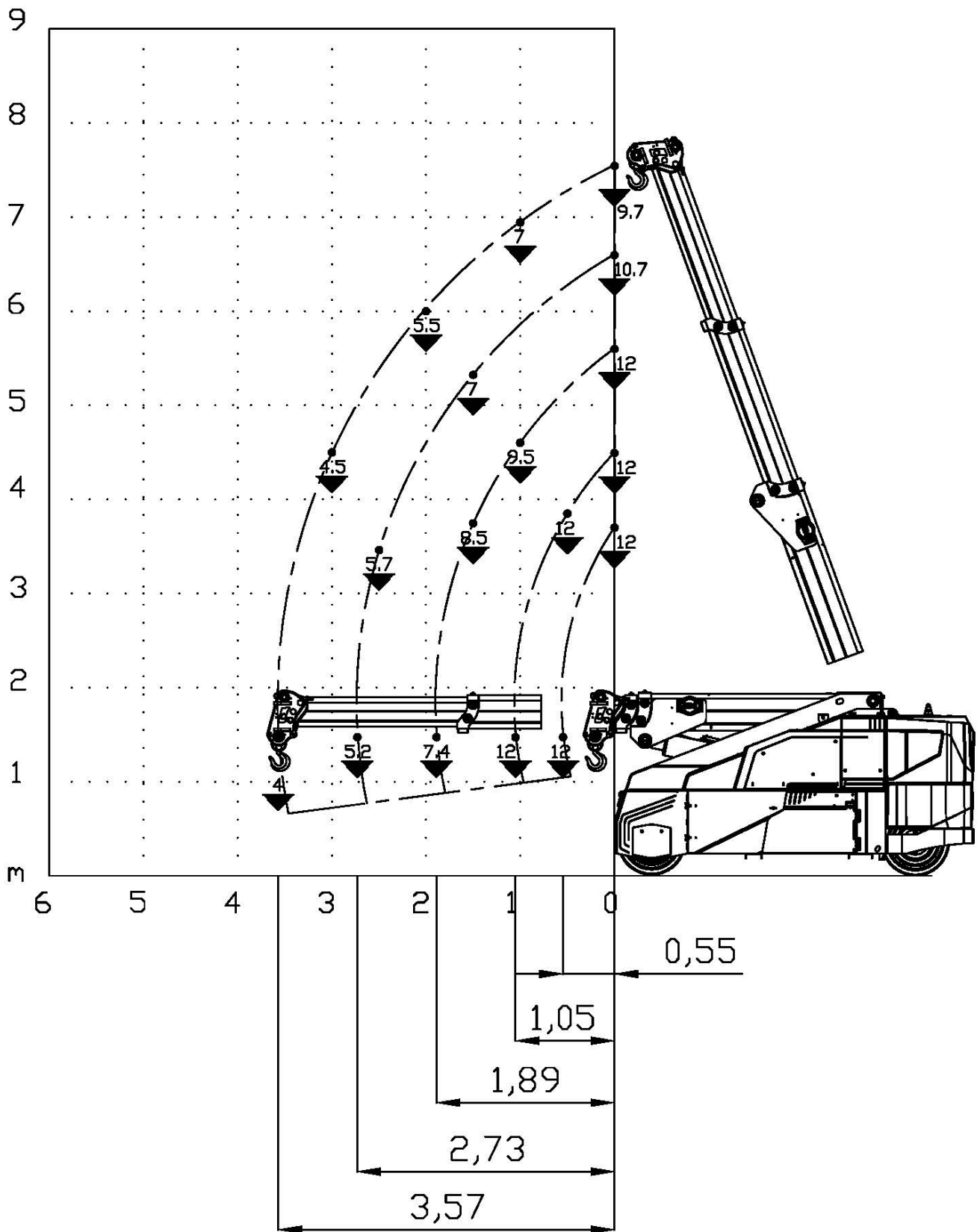

MC 80.06 Z1+Z2

Cod.: 090-DIA-04028

A 1:60

Diagramma di portata (t) - Capacity diagram (t)
 Traglastdiagramm (t) - Tableau des charges (t)
 Lastendiagramm (t) - Diagrama de las cargas (t)

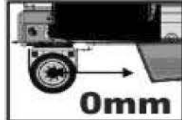
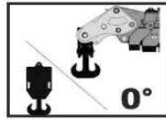

Z1 Z2

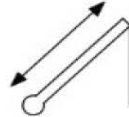

	(t)	2950	3286	3790	4630	5470	6310
	0	11	11				
	0,21	11	11				
	0,5		11	11			
	0,55		11	11,4			
	1			9,1			
	1,05			8,7	8,7		
	1,5				6,9		
	1,89				5,6	5,6	
	2					5,4	
	2,5					4,3	4,3
	2,73					3,9	4
	3						3,6
	3,5						3,1
	3,57						3

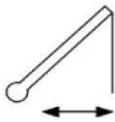

MC80.06

090-DIA-04033

Diagramma di portata (t) - Capacity diagram (t)
 Traglastdiagramm (t) - Tableau des charges (t)
 Lastendiagramm (t) - Diagrama de las cargas (t)

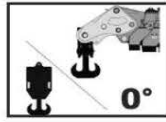

Z1

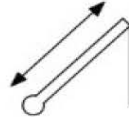

	(t)	2950	3286	3790	4630	5470	6310
	0	11	11				
	0,21	11	11				
	0,5		10,6	10,6			
	0,55		10	10			
	1			6,6			
	1,05			6,3	6,3		
	1,5				4,7		
	1,89				3,8	3,8	
	2					3,7	
	2,5					2,9	2,9
	2,73					2,6	2,6
	3						2,4
	3,5						2
	3,57						1,9

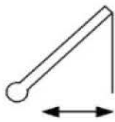

MC80.06

090-DIA-04034

Diagramma di portata (t) - Capacity diagram (t)
 Traglastdiagramm (t) - Tableau des charges (t)
 Lastendiagramm (t) - Diagrama de las cargas (t)

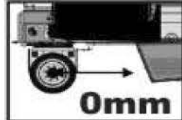
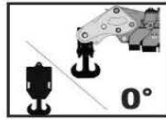

NZ

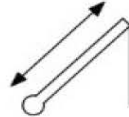

	(t)	2950	3286	3790	4630	5470	6310
	0	11	11				
	0,21	9,2	9,2				
	0,5		6,1	6,1			
	0,55		5,7	5,7			
	1			3,7			
	1,05			3,5	3,5		
	1,5				2,6		
	1,89				2	2	
	2					2	
	2,5					1,5	1,5
	2,73					1,3	1,3
	3						1,2
	3,5						1
	3,57						0,9

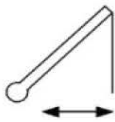

MC80.06

090-DIA-04035

Diagramma di portata (t) - Capacity diagram (t)
 Traglastdiagramm (t) - Tableau des charges (t)
 Lastendiagram (t) - Diagrama de las cargas (t)

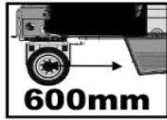
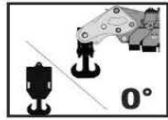

Z1 Z2

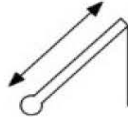

	(t)	2950	3286	3790	4630	5470	6310
	0	11	11				
	0,21	11	11				
	0,5		11	11			
	0,55		11	11			
	1			11			
	1,05			11	9,3		
	1,5				8,5		
	1,89				7,4	6,5	
	2					6,3	
	2,5					5,7	5
	2,73					5,2	4,7
	3						4,5
	3,5						4,1
	3,57						4

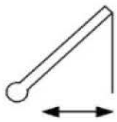

MC80.06

090-DIA-04036

Diagramma di portata (t) - Capacity diagram (t)
 Traglastdiagramm (t) - Tableau des charges (t)
 Lastendiagramm (t) - Diagrama de las cargas (t)

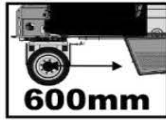
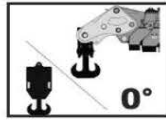

Z1

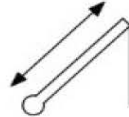

	(t)	2950	3286	3790	4630	5470	6310
	0	11	11				
	0,21	11	11				
	0,5		11	11			
	0,55		11	11			
	1			8,7			
	1,05			8,4	8,4		
	1,5				6,3		
	1,89				5,1	5,1	
	2					4,9	
	2,5					3,9	3,9
	2,73					3,6	3,6
	3						3,3
	3,5						2,8
	3,57						2,7

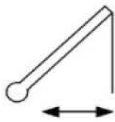

MC80.06

090-DIA-04037

Diagramma di portata (t) - Capacity diagram (t)
 Traglastdiagramm (t) - Tableau des charges (t)
 Lastendiagramm (t) - Diagrama de las cargas (t)

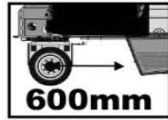
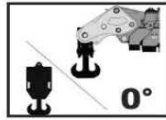

NZ

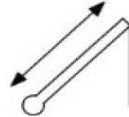

(t)	2950	3286	3790	4630	5470	6310
0	11	11				
0,21	11	11				
0,5		8,2	8,2			
0,55		7,7	7,7			
1			5			
1,05			4,8	4,8		
1,5				3,6		
1,89				2,9	2,9	
2					2,7	
2,5					2,2	2,2
2,73					1,9	1,9
3						1,8
3,5						1,4
3,57						1,4

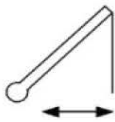

MC80.06

090-DIA-04038

Diagramma di portata (t) - Capacity diagram (t)
 Traglastdiagramm (t) - Tableau des charges (t)
 Lastendiagramm (t) - Diagrama de las cargas (t)

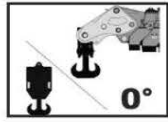

Z1 Z2
Z3

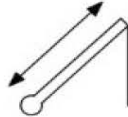

(t)	2950	3286	3790	4630	5470	6310
0	11	11				
0,21	11	11				
0,5		11	11			
0,55		11	11			
1			10,1			
1,05			9,6	8,8		
1,5				7,3		
1,89				6,3	6,3	
2					6	
2,5					4,8	4,8
2,73					4,1	4,1
3						3,9
3,5						3,2
3,57						3,2

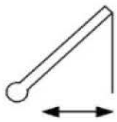

MC80.06

090-DIA-04039

Diagramma di portata (t) - Capacity diagram (t)
 Traglastdiagramm (t) - Tableau des charges (t)
 Lastendiagram (t) - Diagrama de las cargas (t)

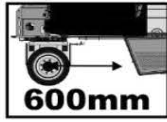
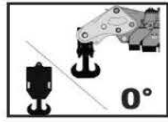

Z1 Z2
Z3

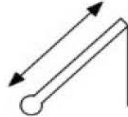

(t)	2950	3286	3790	4630	5470	6310
0	11	11				
0,21	11	11				
0,5		11	11			
0,55		11	11			
1			11			
1,05			11	9,3		
1,5				8,5		
1,89				8,1	6,5	
2					6,3	
2,5					5,8	5
2,73					5,6	4,7
3						4,5
3,5						4,1
3,57						4,1

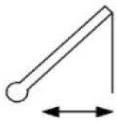

MC80.06

090-DIA-04040

DIAGRAMMA DELLE PORTATE (t)
 CAPACITY DIAGRAM (t)
 TRAGLASTDIAGRAMM (t)
 LASTENDIAGRAM (t)
 TABLEAU DES CHARGES (t)
 DIAGRAMA DE LAS CARGAS (t)

JMG

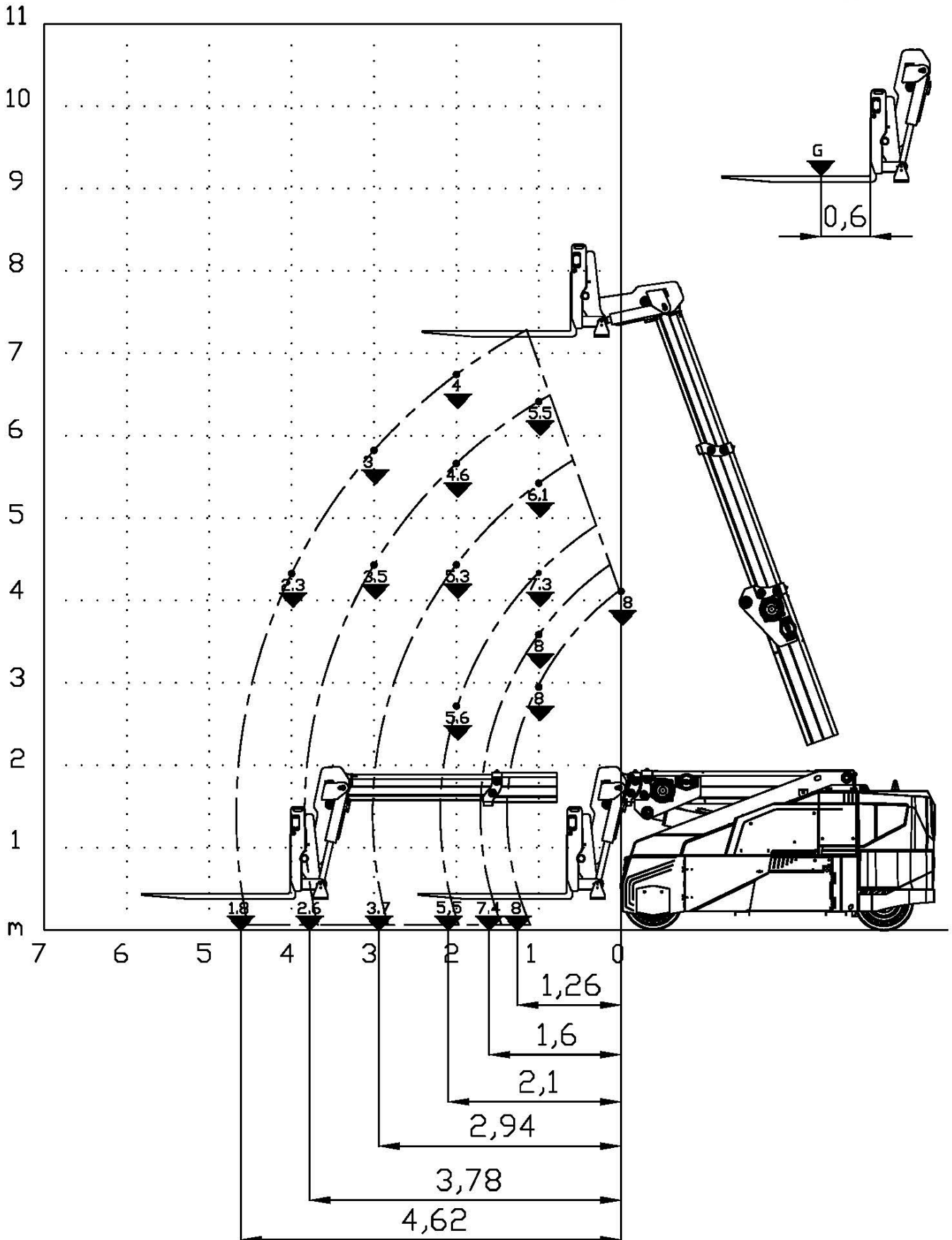

MC 80.06 Z1+Z2

Cod.: 090-DIA-04067

A 1:65

JMG

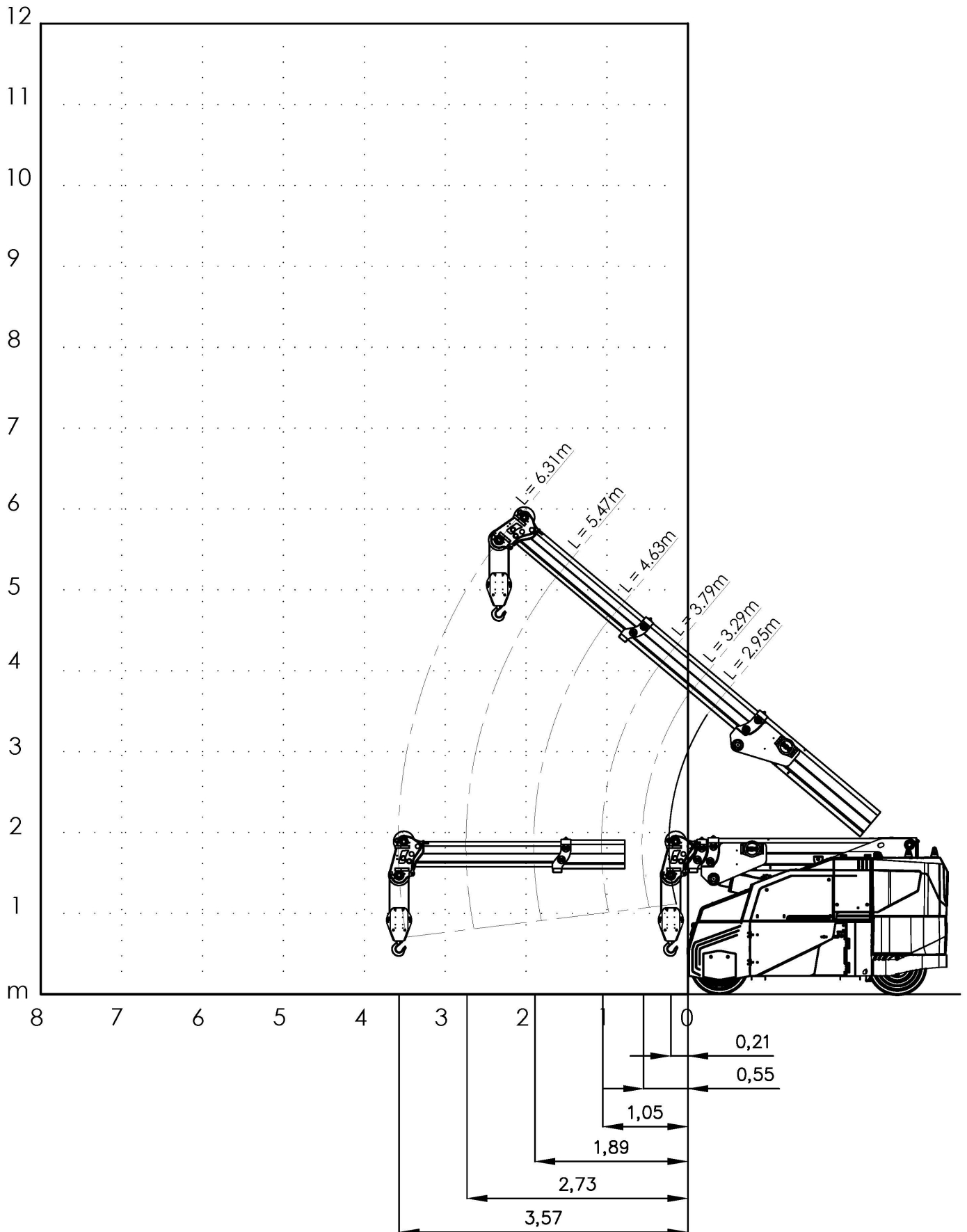

MC 80.06

Cod.: 090-TAR-04011

A 1:65