

Data subject to change without prior notice
Edition 10/2022 © 2022 JMG Cranes S.p.A. All rights reserved
Rev. 2 - 10/22

JMG Cranes S.p.A.

Sales & Service Office

Via Bergamo, 142

26100 Cremona - Italy

t +39 0372 1786738

Production Plant

Via Zuccherificio, 2

29010 Sarmato (PC) - Italy

t +39 0523 8486

e info@jmgcranes.com



Electric Pick & Carry Cranes



MC 650 (metric)

Portata Massima
65.000 kg

www.jmgcranes.com



MC 650

TRAZIONE SULLE RUOTE ANTERIORI CON CONTROROTAZIONE

BRACCIO IDRAULICO CON USCITA PROPORZIONALE

N° 2 GRUPPI DI STERZO INDIPENDENTI

AUTO-CARICAMENTO/SCARICAMENTO DELLE ZAVORRE

TESTA DEL BRACCIO MECCANICA TILTANTE A 3 POSIZIONI









Optionals:

- ARGANO IDRAULICO DA 55 T CON TIRO IN 10°
- STABILIZZATORI FRONTALI REMOVIBILI
- RUOTE ANTITRACCIA
- RADIOCOMANDO
- TRASFORMAZIONI ANTIDEFLAGRANTI
- COLORE PERSONALIZZATO



Informazioni tecniche

Portata Massima kg	65.000
Dimensioni mm	5500x2500x2350



	Trazione anteriore. N°2 motori elettrici AC 16 kW 96 V. Classe d'isolamento H.	LMI.	Sistema elettronico indicatore del carico e limitatore del momento ribaltante
	Complessivo Kg. 45.000 Zavorre removibili Kg. 17.500		Freno di servizio: idraulico con comando a pedale. Freno di stazionamento e soccorso: idraulico con comando automatico
	96 V - 1550 Ah 8 ore di autonomia		In robusta lamiera d'acciaio di qualità piegata e saldata
	Anteriori n° 4 cushion di cui: n 2° 40x20-30" n 2° 40x12-30" Posteriori n.4 cushion 840x356x559		Angolo di inclinazione +65°/-5°
	Posteriore Angolo di sterzo -90°/+90°		Motore elettrico impianto idraulico 2x 35 kW - 96 V AC. Classe di isolamento H.

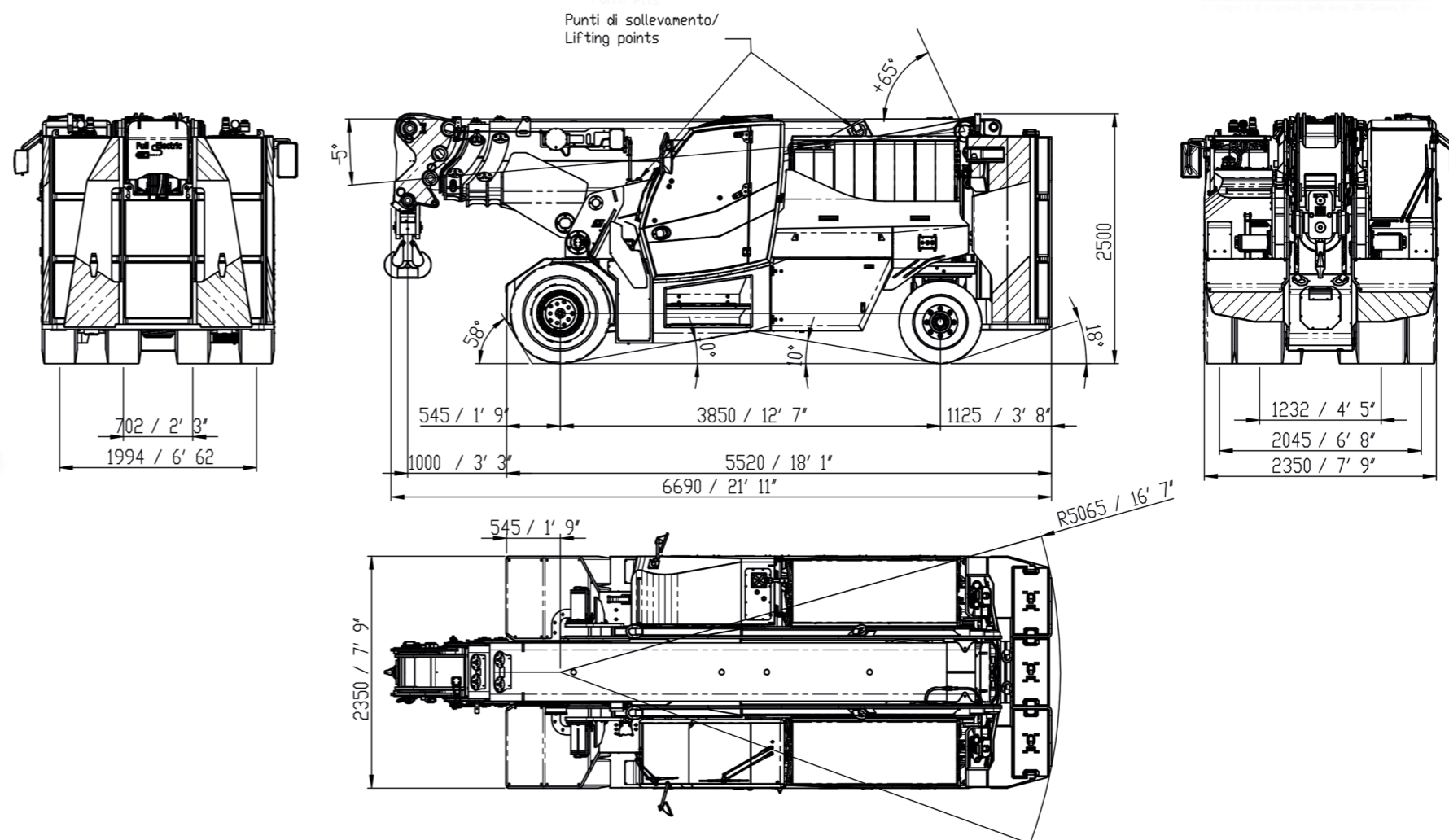

Dimensioni di ingombro



Normative

	UNI ISO 4301-1: A1
	2006/42 CE-2014/30 UE- 2014/35 UE- 2000/14 e successive modifiche
	EN 13000:2014 ANSI/ASME B30.5-2011 e successive modifiche

MC 650

Diagrammi

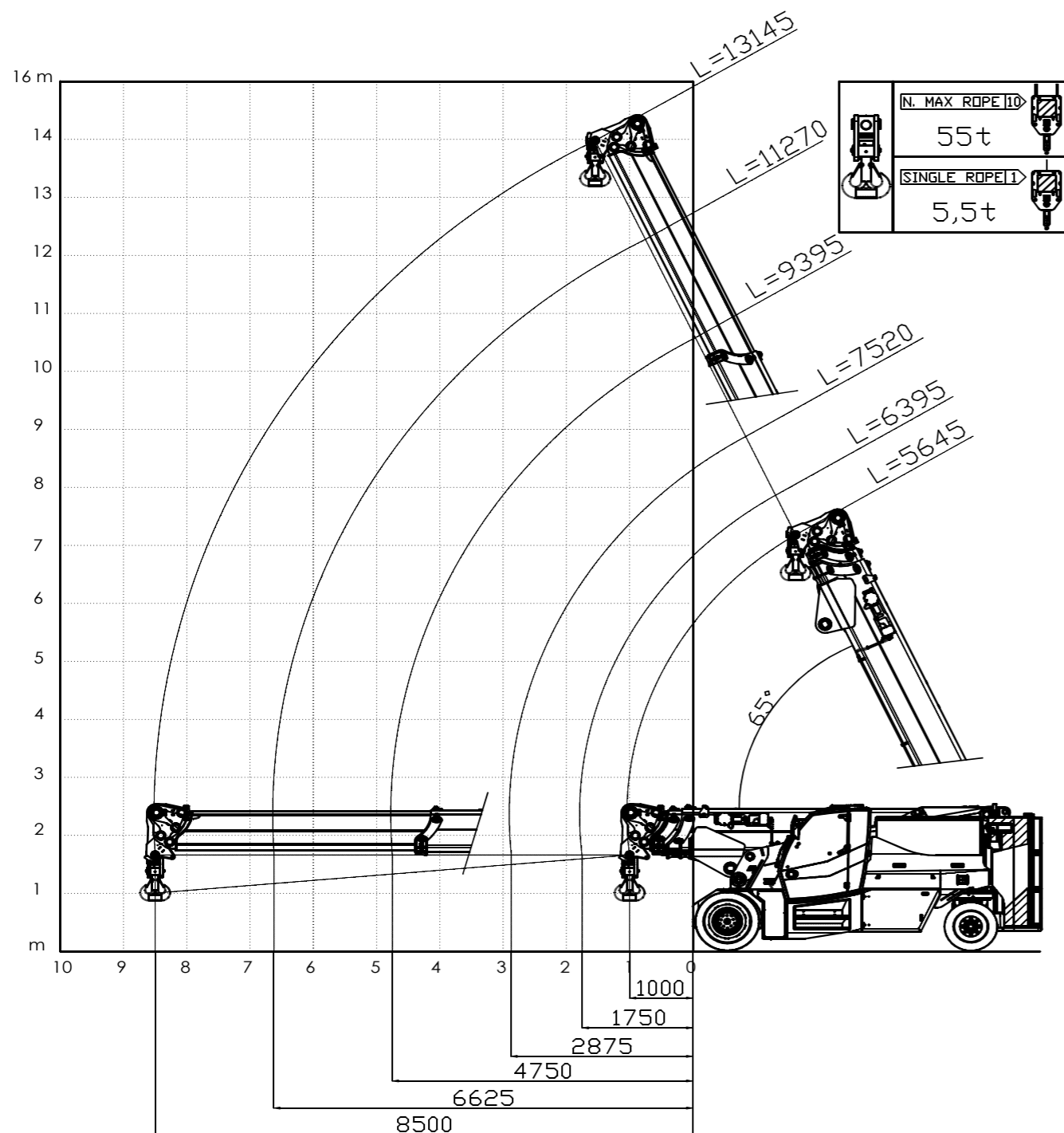

RAGGI DI LAVORO - T0

				Z1	Z2	Z3	Z4
(t)	5645	6395	7520	9395	11270	13145	
0	65	65	61,9	51,7			
0,5	65	65	56,4	46,6	39,2		
1	65	64,7	51,8	42,3	37,3		
1,5		61	47,9	38,8	34	30,5	
1,75		53,8	46,2	37,2	32,4	29,1	
2			44,6	35,7	30,9	27,7	
2,5			40,1	33,1	28,2	25,1	
2,88			35,2	31,2	26,4	23,4	
3				30,6	25,9	22,9	
3,5				28,4	23,9	21,1	
4				26	22,2	19,5	
4,5				23	20,7	18,1	
4,75				21,7	20	17,4	
5					19,4	16,9	
5,5					18,2	15,8	
6					17,1	14,8	
6,5					15,6	13,9	
6,63					15,2	13,7	
7						13,1	
7,5						12,4	
8						11,8	
8,5						10	

Z4 - NO STAB - GRUPPO APERTO

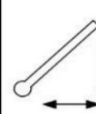

								
	(t)	5645	6395	7520	9395	11270	13145	
	0	65	65	61,9	51,7			
	0,5	40	40,2	40,3	41,6	33		
	1	25,6	26,2	26,4	27,2	27,2		
	1,5		19,1	19,2	19,7	19,8	19,3	
	1,75		16,4	16,8	17,3	17,3	17,3	
	2			14,9	15,2	15,3	15,3	
	2,5			11,9	12,2	12,3	12,3	
	2,88			10,1	10,5	10,6	10,6	
	3				10	10,1	10,1	
	3,5				8,4	8,4	8,5	
	4				7,1	7,2	7,2	
	4,5				6	6,1	6,2	
	4,75				5,5	5,7	5,7	
	5					5,3	5,3	
	5,5					4,6	4,6	
	6					4	4	
	6,5					3,4	3,5	
	6,63					3,2	3,4	
	7						3,1	
	7,5						2,7	
	8						2,3	
8,5						1,9		

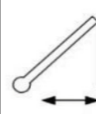
NZ - NO STAB - GRUPPO CHIUSO

								
	(t)	5645	6395	7520	9395	11270	13145	
	0	65	65	61,9	51,7			
	0,5	65	65	56,4	46,6	39,2		
	1	65	64,7	51,8	42,3	37,3		
	1,5		61,3	47,9	38,8	34	30,5	
	1,75		55,9	46,2	37,2	32,4	29,1	
	2			44,6	35,7	30,9	27,7	
	2,5			33,2	33,1	28,2	25,1	
	2,88			26,9	27,9	26,4	23,4	
	3				26,3	25,9	22,9	
	3,5				21,2	21,3	21,1	
	4				17,6	17,7	17,7	
	4,5				14,9	15	15	
	4,75				13,6	13,9	13,9	
	5					12,9	13	
	5,5					11,3	11,3	
	6					9,9	10	
	6,5					8,8	8,9	
	6,63					8,4	8,6	
	7						7,9	
	7,5						7,1	
	8						6,4	
8,5						5,7		

NZ - STAB - GRUPPO CHIUSO

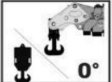
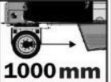
MC 650

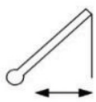
		 0°	 1000mm	 600mm	NZ		
							
	(t)	5645	6395	7520	9395	11270	13145
	0	65	65	61,9	51,7		
	0,5	65	65	56,4	46,6	39,2	
	1	65	64,7	51,8	42,3	37,3	
	1,5		61,3	47,9	38,8	34	30,5
	1,75		61	46,2	37,2	32,4	29,1
	2			44,6	35,7	30,9	27,7
	2,5			36,5	33,1	28,2	25,1
	2,88			29,7	30,7	26,4	23,4
	3				29	25,9	22,9
	3,5				23,4	23,5	21,1
	4				19,5	19,6	19,5
	4,5				16,5	16,6	16,7
	4,75				15,2	15,4	15,5
	5					14,4	14,4
	5,5					12,6	12,6
	6					11,1	11,2
	6,5					9,8	9,9
	6,63					9,5	9,7
	7						8,9
	7,5						8
	8						7,2
	8,5						6,5

NZ - STAB - GRUPPO APERTO